

**VERSA  
CLIMBER**

**SM**

---

---

**OPERATIONAL  
MANUAL**



MADE IN USA

## TABLE OF CONTENTS

	Page
GENERAL INTRODUCTION .....	5
SELECTING EXERCISE TIME .....	5
CALORIE BURN RATE .....	5
FINDING YOUR TARGET HEART RATE .....	6
STEPPER USER GUIDE .....	7
CLIMBING USER'S GUIDE .....	7
SELECTING AN OPPONENT .....	8
SELECTING A LANDMARK .....	8
MODULE DISPLAY .....	8-9
PROGRAMMING HEART RATE .....	9
USING HYDRAULICS TO CONTROL SPEED .....	10
VERSACLIMBER SPECIFICATIONS .....	10
UNPACKING INSTRUCTIONS .....	11
SM PART LAYOUT.....	12
ASSEMBLY INSTRUCTIONS .....	13-16
OPTIONAL ARM EXTENDERS/QUICK RELEASE HAND GRIPS.....	16
ASSEMBLY INSTRUCTIONS FOR HI-TRI & HI-FIVE .....	17
MAINTENANCE INSTRUCTIONS .....	17-20
TROUBLE SHOOTING .....	19-20
OPTIONAL SEAT ATTACHMENT .....	20-21
CONDITIONING: DEVELOPING STRENGTH, POWER, AND ENDURANCE .....	21-25
USING VERSACLIMBER WITH MINOR INJURIES .....	25-26
WALL MOUNT INSTRUCTIONS .....	27-29
SPARE PARTS .....	30-31
WARRANTY/CONTACT INFO.....	31-32

---

### NOTE

*BEFORE EXERCISING ON THE VERSACLIMBER, READ THIS OPERATION MANUAL THOROUGHLY. INSTRUCT OTHERS HOW TO USE THE MACHINE IN ACCORDANCE WITH THE PROCEDURES OUTLINED IN THIS MANUAL. ADDITIONAL MANUALS ARE AVAILABLE UPON REQUEST FROM HEART RATE, INC.*

*BEFORE BEGINNING THIS OR ANY OTHER EXERCISE PROGRAM, CONSULT YOUR PHYSICIAN. THIS IS ESPECIALLY IMPORTANT FOR THOSE INDIVIDUALS OVER THE AGE OF 30 AND THOSE WHO HAVE KNOWN HEALTH PROBLEMS. HRI ASSUMES NO RESPONSIBILITY FOR PERSONAL INJURY OR PROPERTY DAMAGE SUSTAINED BY OR THROUGH THE USE OF THE VERSACLIMBER.*

---

### GENERAL INTRODUCTION

The VersaClimber, introduced in 1981, was the first climbing exercise machine on the market; and to this day remains the leader as a true total body conditioning unit. This full body climbing exercise machine provides an alternating arm and leg action against gravity with variable force, stroke length and speed. All the major muscles of the arms, chest, shoulders, back, hips, butt and legs are used while climbing. The VersaClimber has been proven worldwide and is a widely accepted total body exerciser that is used by health clubs, sports medicine facilities, military, fire departments, corporate gyms and wherever groups of people gather to exercise.

To climb, the person stands in a vertically erect position with both feet level on pedals while grasping two handgrips set at about shoulder height. To initiate climbing motion, step down on one foot pedal while pushing up on the hand grip. When the foot and hand move vertically downward, the other foot and hand move vertically upward and then alternate synchronously. A cyclic action of the arms and legs is performed that simulates motion of climbing an endless ladder for any selected step height, time, rate and distance. A microcomputer monitors and displays climbing performance, heart rate, calories, distance, time and gives audible instructions and motivational messages during the exercise. The machine is oriented at a 75-degree climb angle.

---

### NOTE:

**Don't Climb Too Fast. Beginners Should Take a 4-6 inch step at a Gentle Pace**

---

First time users of the VersaClimber have a tendency to climb too fast and to take too long a step. Until users become thoroughly familiar with the VersaClimber, it is important to take short, slow steps. To maintain a shock and trauma free motion, it is mandatory not to "bottom out" or impact the pedals at the end of each stroke.

### SELECTING EXERCISE TIME

If you are not already warmed up, a warm up period of at least 5 to 10 minutes should be included in each VersaClimber workout. Taking a short step at a slow climbing speed during the warm up period is the key to a great workout. The first time user can easily climb for 15 to 20 minutes by including a slow 5 minute warm up and a 3 to 5 minute cool down period. With repetitive use it is possible to build up to longer climbs at higher speeds.

Many individuals enjoy 60 minutes or more of uninterrupted climbing. After each workout, note exercise time, climbing speed and height climbed for establishing a goal for future sessions. Use heart rate and perceived exertion to determine if you are at a comfortable exercise level. Remember that work intensity and calorie burn rate is based on climbing speed. If the exercise is too hard, slow down.

### CALORIE BURN RATE

Full body climbing ranks highest in calories burned even though climbing speed is slower than other activities. First time users often try to maintain the speed they use in other activities and tend to over exert themselves. It is important to remember that because VersaClimbing is a total body climb against gravity, it is not necessary to climb at a high rate of speed demonstrated as follows.

---

### NOTE:

**TO MAINTAIN TRAUMA FREE MOTION, IT IS MANDATORY THAT YOU DO NOT, UNDER ANY CIRCUMSTANCES, "BOTTOM OUT" AT THE END OF EACH STROKE. ALSO, DO NOT HIT THE STEP HEIGHT LIMITERS WHEN THEY ARE IN USE.**

## HOW TO FIND YOUR TARGET HEART RATE?

Heart rate is the best indicator of exercise intensity. Use your heart rate and level of perceived exertion (how you feel) as a guide to determine if you have selected the proper “LEVEL OF CONDITIONING”. The following HEART RATE TRAINING ZONE CHART may be used to assist you in selecting your appropriate heart rate training zone.

### HEART RATE TRAINING GUIDE

1. Find your age at the bottom of the chart.
2. Beginners follow the column to 70% of your maximum heart rate.
3. Advanced follow the column to 85% of your maximum heart rate.
4. Exercise at your appropriate heart rate.

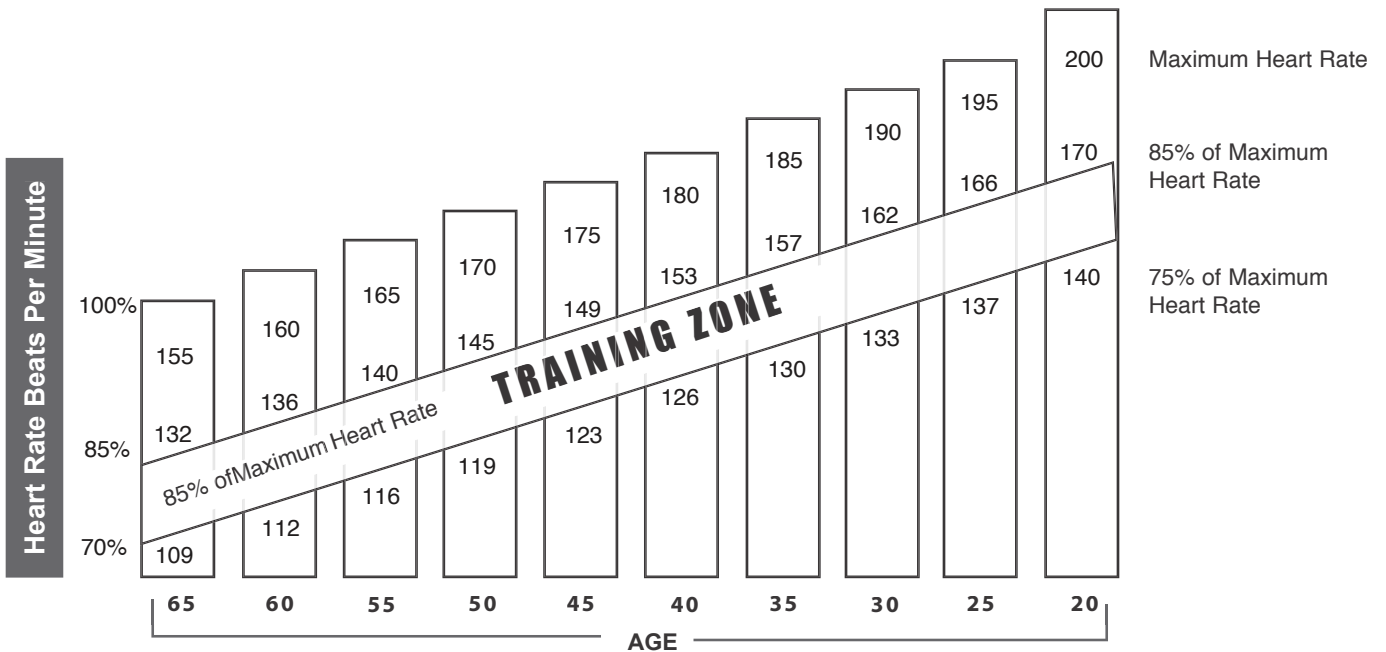

**NOTE:**  
**TO MAINTAIN TRAUMA FREE MOTION, IT IS MANDATORY THAT YOU DO NOT, UNDER ANY CIRCUMSTANCES, “BOTTOM OUT” AT THE END OF EACH STROKE. ALSO, DO NOT HIT THE STEP HEIGHT LIMITERS WHEN THEY ARE IN USE.**

<b>CALORIES ACTIVITY</b> (For a 150 lb person)		Calories Burned Per Hour
<u>SPEED</u>		
Walking	3.0 mph	228
Bicycling	9.4 mph	384
Swimming	2.0 mph	486
Running	7.5 mph	792
Stepping	1.9 mph	864
<b>VersaClimbing</b>	<b>0.9 mph</b>	<b>972</b>

### STEPPING USER GUIDE

The side handrails not only provide support while getting on and off the VersaClimber but they offer the option of Stair Stepping. By holding the handrails to the side of the body and stepping with the legs only, the glutes, quads, hamstrings, calves and shins can achieve a complete lower body aerobic and strength exercise.

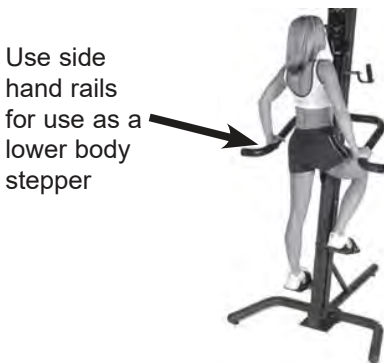

Two cardio machines in one.

The SM features a 1-20 inch step height. By shifting the hands from the stationary handrails to the moving handgrips, the machine automatically converts from a stepping machine into a total body climbing machine or back to a stepping machine simply by changing hand position.

### CLIMBING USER GUIDE

Hold handrails for support and step up on the pedals until both **feet are level**. With both feet at the same level, position handgrips at about chin or shoulder height. Adjust handles if necessary by depressing the pin at the end of the handgrip. Remove the handgrip and reinsert it fully into another position and release the pin.

### NOTE:

WHEN GRASPING THE HAND RAILS OR HAND GRIPS, KEEP FINGERS AND THUMBS ON THE FOAM PADDING OF THE HANDRAILS OR RUBBER GRIPS OF THE HANDLES. DO NOT GRASP OR EXTEND ANY PORTION OF THE HAND BEYOND THE FLANGES OF THE MOVING HAND GRIPS. DO NOT HOLD ONTO THE VERTICAL POST.

No matter what level of conditioning you are at, start slow and take a 4" to 6" step height. Only take a step or stroke length that feels comfortable. Do not take long steps or you will tire quickly!

Although a step height of up to 20 inches is available, it is not necessary to take the maximum stroke length to receive cardiovascular and strength benefits.

### RANGE OF MOTION LIMITERS (optional upgrade)

To ensure that users maintain a short stroke length, range of motion limiters have been provided for each machine. These "stops" can be set in the pedaling, stepping or climbing positions and are designed for safe, controlled workout routines. They are easily installed and adjustable to 6 different range limitations.

#### Range of Motion Limiter Bolts

Limits step range of motion by setting bolt in 1 of 6 numbered settings.



The range of motion "limiters" or "stops", are located on the slide bar inside the track just above each left and right pedal. Extra holes have been threaded into the slide bar to allow the limiters to be adjusted up or down in 2 inch increments.

NOTE: Unless rehabing an injured leg, limiter bolts should remain at setting 6

To decrease the range of motion, unscrew both limiters from their lowest position (position #6). Level pedals and re-install the limiters at the highest position setting 1. Both left and right limiters should be in the same position on both sides.

Hold the stationary hand rails to the front or side of the body and begin stepping. Notice the limiters restrict the step height. Take short steps up to the stroke length the limiters will allow. Do not bottom out or hit the limiters against the frame. Do not over exert yourself. Step rate should be easy enough so that a minimum exercise of 10 minutes can be achieved.

## QUICK START

Push QUICK START on the module and follow verbal user instructions. Time, Rate, Distance, Step Height and other information is displayed. See page 6 for detailed display functions including Heart Rate and Calories.

Begin climbing by taking a **very short** step stroke length of approximately 5 inches at a speed of 20 feet per minute for approximately 5 minutes. After 5 minutes the step height and climbing speed can be gradually increased if desired.

To maintain a shock and trauma free motion, do not, under any circumstances, "bottom out" at the end of each stroke.

---

### CAUTION:

**IMMEDIATELY DISCONTINUE THIS OR ANY EXERCISE IF THERE IS ANY DISCOMFORT, SHORTNESS OF BREATH OR DIZZINESS.**

---

## MODULE DISPLAY

The control module consists of 17 push buttons with associated back lit text descriptors, a 32 character LCD display. The text descriptors are back lit descriptions of what function or activity is currently associated to each button. Here is a brief discussion of the functions provided by each instruction.



NOTE: Display module does not need to be unplugged; it is perfectly fine to keep module luminated 24 hours a day.

## YELLOW QUICK START BUTTON

When pressed, it clears the display of any previous information and verbally guides the first time user through a 15 minute workout.

## SELECT AN OPPONENT

Press YELLOW QUICK START button, then press blue SELECT OPPONENT button repeatedly to select one of 6 virtual opponents to race against.

Then press LOCK SELECT. Next, select ENTER TIME use yellow arrow keys up/down then press LOCK SELECT button. Start climbing.

## VIRTUAL OPPONENT

The opponent you select will climb at the average speed listed below. If you are not able to keep up with the opponent you selected, slow down and finish the 15 minute race. Select a slower opponent for the next workout.

	<u>SPEED</u> <u>FEET/MIN</u>	<u>DISTANCE</u> <u>FEET</u>
1. BEGINNER	35	525
2. INTERMEDIATE	65	975
3. COMPETITOR	95	1425
4. CHAMPION	120	1800
5. ELIMINATOR	160	2400
6. OLYMPIAN	200	3000

## SELECT A VIRTUAL LANDMARK

Press this button repeatedly to select one of six Landmark goals. Then press the LOCK SELECT button to start. This is a distance challenge. You climb at your own desired speed.

<u>LANDMARK</u>	<u>HEIGHT</u>
1. Washington Monument	554 FT
2. Eiffel Tower	984 FT
3. Moscow Tower	1,762 FT
4. El Capitan	3,297 FT
5. Vesuvius	3,900 FT
6. Mount Olympus	9,731 FT

Select a landmark based on the total distance climbed during previous workouts.

## ENTER WEIGHT

Press this button to enter your weight which is used to calculate caloric burn rate. Use the yellow LOCK SELECT arrows to raise or lower your weight in the display until it matches your weight within plus or minus five pounds (or two kilograms). Then press the LOCK SELECTION button to enter your weight into the computer.

### ENTERING TIME

Press this button to increase or decrease the default workout period of 15 minutes. Use the yellow LOCK SELECTION **arrows** to raise or lower the number in the display until the desired time is displayed. Then press the LOCK SELECTION button to enter your time into the computer.

### LOCK SELECTION

Press this button to enter user selected values into the computer.

### YELLOW LOCK SELECTION ARROWS

These buttons are used to raise or lower the number in the display.

#### “Upper” Left SELECT button.

Press this button to switch the display between ELAPSED TIME and TIME REMAINING in the workout period. The remaining time display stops at zero while the elapsed time continues counting up to 99 hours :59 minutes :59 seconds.

#### “Center” SELECT button.

Press this button to switch between TOTAL CALORIES and CALORIES PER HOUR.

#### “Upper” Right SELECT button.

If the machine is not running in one of the specialty modes (Opponent, Landmark, Heart Rate Monitor) this button has no function as both STROKE LENGTH and DISTANCE PER MINUTE will be displayed continuously. When any of the specialty modes are selected, this button will switch the display between STROKE LENGTH and DISTANCE PER MINUTE

#### “Lower” Left SELECT button.

Press this button to switch between metric and imperial display units.

“Lower” Right SELECT button. Press this button to switch between OPPONENT’S TOTAL DISTANCE and OPPONENT’S DISTANCE PER MINUTE. This button is only active when virtual **opponent mode** is selected.

## SPECIALTY MODES HEART RATE MONITORING

Press this button to select HEART RATE MONITORING MODE. Polar chest strap must be worn.



Polar Chest Strap

Place adjustable strap directly below pectoral muscle >

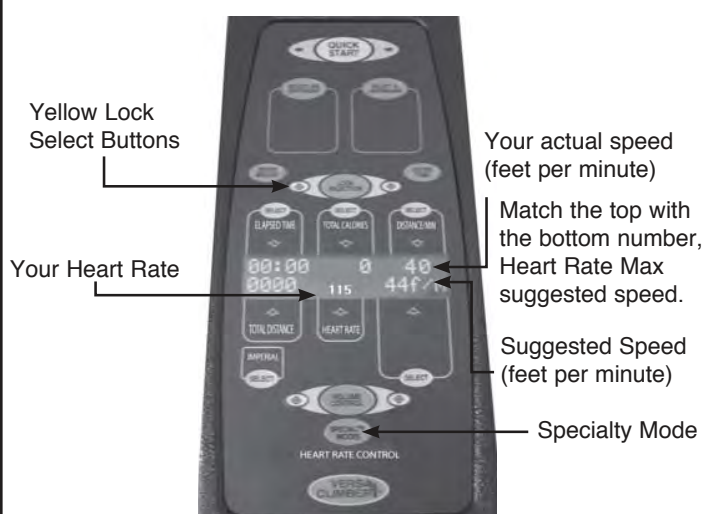
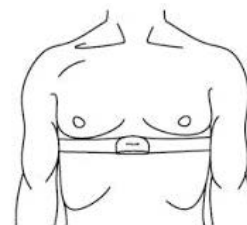

1. Press Quick Start
2. Press Specialty Mode
3. Using yellow lock selection buttons, enter target Heart Rate--(see chart on page 5)
4. Press LOCK SELECT BUTTON when complete.
5. Climb at suggested speed (feet/per minute) as shown in the lower right hand corner.
6. Match your actual feet/per minute (upper right hand corner) with the suggested speed.
7. Every :30 seconds target feet/per minute will be updated.
8. In 5 minutes, you will be at target heart rate.

## USING HYDRAULICS TO CONTROL SPEED

Beginners and individuals who are deconditioned may use the resistance to control their climbing speed—by slowing the step speed down. The hydraulic control knob is located at the bottom of the control console.



You can use the Resistance in 2 ways:

- Slower Step:** Turn knob clock wise
- Faster Step:** Turn knob counter clock wise

By turning the control knob “clock wise” will slow down the stepping speed when only your body weight is applied. However, by forcing the push and pull motion will create a harder work out. Beginners use the increased resistance to slow the stepping speed with out forcing the step down-this will produce a comfortable, less intense work out.

You can create “zero” resistance workout by turning the knob all the way “counter clockwise”. However, by eliminating the tension the speed by which you climb is also increased: more steps in same amount of time. Beginners should take short (4-6 inch) slow paced steps in order to maintain an easy going climb rate. Conversely, if a more intense work out is desired, step faster with longer stride.

VersaClimbing uses many more muscles than jogging, pedaling, stepping or elliptical exercises and is therefore performed at a slower cyclic rate and speed. Speed in “Feet Per Minute” is an accurate guide for the amount of work being done.

A reasonable starting rate for a person in good condition would be about 60 to 80 feet per minute. After a few minutes of exercise, heart rate should be checked and the climb rate increased or decreased appropriately to bring the user to their target heart rate zone.

## VERSACLIMBER SPECIFICATIONS

### PHYSICAL SIZE

Height	7 feet, 10 Inches
Footprint	43 Inches x 46 Inches
Weight	155 pounds (70 kg)

### FUNCTIONAL FEATURES

Pedal Step Height	0 to 20”
Arm Stroke Length	0 to 20”
Overall Climb Rate	Ability Of Person Climbing
Hydraulic Climb Rate Control	6-107 m/min
Hydraulic Force Control	0 To 500 lbs.
Climb Angle	75 Degrees
Vertical Lift Factor (% slope)	96.6 Percent

### USER ACCOMMODATIONS

Level of Physical Fitness	Novice To Elite
Climber’s Height	4’ 2” to 6’ 7”
Climber’s Weight	65 lbs. to 352 lbs.
Age and Sex	Any

### MODULE DISPLAY FUNCTIONS

Exercise Time	0 to 99.9 Hours
Exercise Rate	0 to 351 FT/min
Exercise Distance	0 to 9,999 FT
Step Height	0 to 20 inches
Race against opponent	35 to 200 FT/min
Climb a Landmark	(Distance) 554 to 9731FT
Heart Rate Display	30 to 235 (BPM)
Calorie burn rate	0-2000
Display Units	Imperial and Metric
Audio	Volume Control
Power Transformer	110 Volt AC



**TOOLS REQUIRED FOR ASSEMBLY OF A SINGLE UNIT:**

- One Phillips screw driver.
- Two 9/16" wrenches.
- Two able bodied persons are required for assembly.

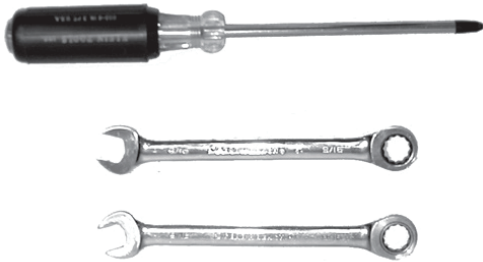

**UNPACKING INSTRUCTIONS**

The following items are packaged in the container.

**EQUIPMENT:** (single unit SM)

- Vertical frame/post with control console attached.
- Two foot pedals.
- Two quick release hand grips.
- One front curved tubing base and two stable pads with nuts.
- One back straight tubing base.
- One brace, post to back base.
- Two side handrails.
- One plastic Pump Cover.
- One transformer. 110 volt AC Adapter.



A. (2) Base Bolts 3/8" x 3 3/4" long



B. (4) Base Bolts 3/8" x 5/8" long



C. (3) 3/8" lock nuts



D. (3) Side Hand Rail Bolts 3/8" x 4 1/4" long



E. (1) 3" Hand Rail Spacer



F. (3) 3/8" lock nuts



G. (4) Foot Pedal Bolts 3/8" x 1 1/2"



H. (1) 3/8" lock nut

1. Remove the shipping container's top cover. Then remove the wooden cross support that holds the mainframe down and the two bolts at the end of the container. Using two people, carefully remove the vertical mainframe from the container and lay the machine on the floor with pump supported on the wooden cross support (see photo below). Avoid lifting the machine by or setting the machine on any portion of the black plastic housing or plastic oil accumulator.

Hydraulic pump

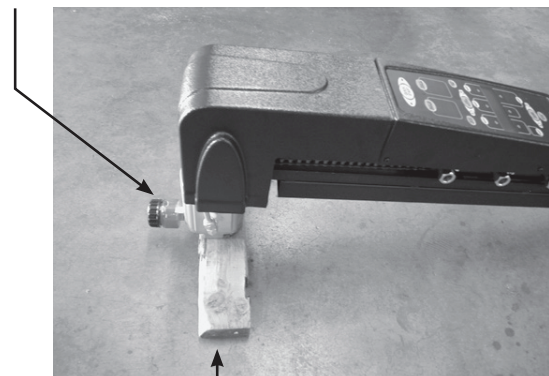

Support pump, when unit is laying on the floor.

Protect the oil reservoir and the black plastic computer housing by supporting the Versa Climber hydraulic pump on wooden cross support from wooden crate.

## SM PART IDENTIFICATION

SM Top Cover \_\_\_\_\_  
[Part# 015.25.000]

\_\_\_\_\_ Pump Cover  
[Part# 015.21.000]

\_\_\_\_\_ Quick Change Straight Handle  
[Part# 101.06.000]

SM Handle Rail \_\_\_\_\_  
[Part# 182.00.005]

\_\_\_\_\_ Pedal Assembly  
[Part# 101.04.000]

Front Curved Base \_\_\_\_\_  
[Part# 182.03.002]

\_\_\_\_\_ Brace  
[Part# 182.00.008]

Back Base \_\_\_\_\_  
[Part# 182.03.001]

## FRONT U BASE STABILIZER INSTRUCTIONS (When attaching the front curved floor base)

2. Two Stabilizer Knobs for U Base.

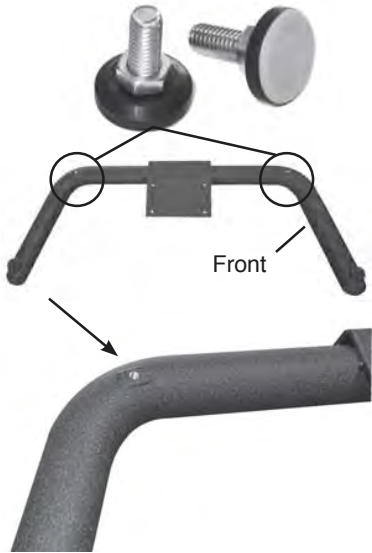

3. Locate the threaded inserts on the underside of the front U base at the sections that curve.



4. Screw in stabilizers in both threaded holes on front base.



Make sure to screw the stabilizer all the way down into the threaded hole, as seen above.



Front base with stabilizer knobs attached.



Front base with stabilizer attached, when your VersaClimber is completely assembled and placed where it will be used, you can now adjust the stabilizer knobs down.



5. Screw down knobs until pads are touching the floor or just resting on floor.



6. Once both knobs are set into position, spin the hex nut up until secured at the bottom of the front base tube then tighten firmly with a 9/16" open wrench, to lock stabilizer in place.



7. Attach the front curved tubular floor brace to the post. Using four hex head bolts, 3/8" x 5/8" long bolts, screw down until firmly tight.



8. Screw in (4) self tightening base bolts.



9. Securely **TIGHTEN** all (4) bolts.



10. Using two people lift and hold VersaClimber in upright position.



11. Attach back tubular floor brace to post with two hex head bolts, 3/8"x 33/4" long. (2) 3/8" lock nuts. **DO NOT TIGHTEN FULLY AT THIS TIME.**



12. Attach tubular brace between post and back tubular floor base with (2) 3/8" lock nuts. **DO NOT TIGHTEN FULLY.**



13. After tubular brace is in place, go back and **FULLY TIGHTEN** the two 3/4" long base bolts.



14. Then go back and **TIGHTEN FULLY** the TOP lock nut on the tubular brace.



15. Next, tighten the BOTTOM lock nut on the back brace to complete post assembly.



16. Attach foot pedals with "L" shape bracket pointing up, using (2) 3/8" x 1 1/2" long hex head bolts.



17. Securely **TIGHTEN** foot pedals. **NOTE: It is recommended to visually inspect foot pedals and tighten bolts every two months and pedal shaft replacement every three years.**



18. Attach side handrails with (3) hex head bolts 4 1/4" long and (3) 3/8" lock nuts.

19. Join left and right hand rails.  
Loosely attach two 3/8" lock nuts nearest to the inside center of machine.



Insert 3" long spacers and **FULLY TIGHTEN ALL** three bolts and nuts.



Install quick release handgrips by depressing pin with thumb and insert into top portion of unit.



With the post supported or after VersaClimber is upright, slip pump cover into place. Attach with four Phillips pan head screws 1/4" x 1/4" long. **DO NOT OVER TIGHTEN.**



Plug the transformer into the back of the post and a 110 volt wall socket.

### ARM EXTENDERS (Optional upgrade)

On the standard SM a person up to 6' 3" tall has a full arm extension while climbing. With optional arm extenders a 6'9" inch person gets a full stretch while climbing.

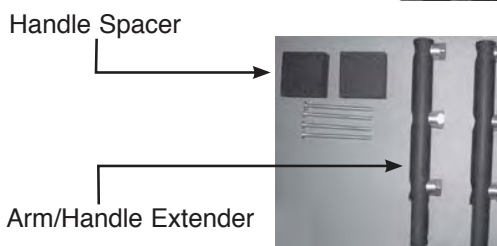
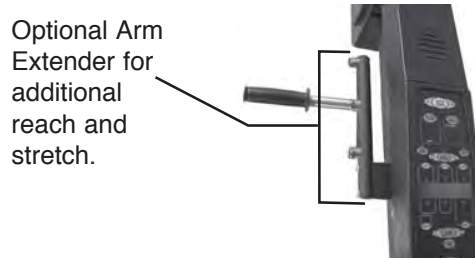

(Optional) Attach each handle spacer and handle extender with two, 1/4" screws x 4" long.

## ASSEMBLY INSTRUCTIONS FOR HIGH-TRI AND HIGH-FIVE



Protect the oil reservoir and the black plastic computer housing by supporting the VersaClimber hydraulic pump on a block of wood or other spacer, (see page 11).

Lay the VersaClimber post on the floor prior to assembling hand rails or foot pedals.

Attach the circular plate to the top of one VersaClimber with 4 hex head bolts, 3/8" x 1" long and 4 3/8" lock nuts (Do not fully tighten).

Attach second VersaClimber to the circular plate in a similar fashion. Do not fully tighten nuts.

Lift assembly of two VersaClimbers upright. Place third VersaClimber into position and tighten bolts to circular plate **loosely**.

Connect the bases of the VersaClimbers together with the tubular floor ties using two hex head bolts 3/8" x 11/4" long and two lock nuts per machine.

To complete High-Tri or High-Five configuration securely tighten all bolts at the base of the machines and then in the circular plate at the top of machines.

Attach foot pedals with "L" shaped bracket pointing up, using two 3/8" x 11/2" long hex head bolts. **FULLY TIGHTEN.**

---

### NOTE:

We recommend replacing PEDAL SHAFT every three years.

---

Attach handrails with three hex head bolts 3/8" x 31/2" long and one 3" long spacer.

(Optional) Attach each handle spacer and handle extender with two 1/4" screws x 4" long.

Install handgrips by depressing pin with thumb and insert.

## MAINTENANCE INSTRUCTIONS

**MECHANICAL DESCRIPTION** - The VersaClimber consists of a mainframe made of two rectangular tubes that are welded together. The mainframe is supported by a base plate and bracket that are bolted to it. A shaft and sprocket is located at the top of the mainframe. The shaft ends are supported with ball bearings. One end of the shaft is coupled to a digital shaft encoder that is used to transmit climb

rate and distance data to the display.

---

### WARNING NOTICE

**In order to maintain highest safety level of equipment, a regular examination is required for damage and wear. This requires a visual inspection of connectors, cables, chains, sprockets, pedals, handles etc. on a regular basis.**

### NOTICE

**Replace defective components immediately and/or keep equipment out of use until repair is made.**

---

Two rectangular bars that carry the handle grips and foot pedals are located inside the two rectangular tubes. These bars also carry rollers and slide bearings. They are attached to a roller chain that passes over the top and bottom sprockets and connect the bars together. While the VersaClimber is in use, the bars travel vertically up and down inside the rectangular tubing whenever the person climbing exerts sufficient upward or downward forces on the foot pedals or handles. There are rubber shock mounts located under the foot pedal shafts to absorb any shock if the twenty-inch stroke is exceeded. The digital encoder and micro-computer electronics are enclosed in a black plastic housing mounted on the upper portion of the machine.

### THE HYDRAULIC SYSTEM

The hydraulic system consists of a heavy duty, reversible gear pump. A flow control valve is connected between the input and the output ports with copper tubing and heavy duty high pressure tube fittings. A clear oil fill reservoir is located on top of the pump, at the very top of the unit.

---

### NOTE:

The oil in the pump reservoir always darkens in color and most of the time, turns black in color. This is normal.

---

The hydraulic resistance is developed in a permanent closed loop system filled with hydraulic oil that does not require changing. The oil is maintained in the system with one static seal and one rotating shaft seal. The rotating shaft seal is rated for continuous duty at operational pressures. If a large amount of slack (more than 1/2" travel) develops when reversing the stepping motion, this indicates a possible loss of oil from the system. Visually check the fittings and the shaft seal for oil leaks. Tighten any leaking fitting and then fill the reservoir with oil up to 1/2" from the top.

## ROLLER AND SLIDE BEARINGS

There are rollers and slide bearings made from high pressure application moly-disulfide filled nylon on each oscillating bar. The roller bearings are held on with 3/8" shafts and press-on grip rings. The slide bearings are held in place with two 3/8" pins. The slide bearings have lubrication points. This bearing material is expected to be maintenance free for years. The bearings are lightly lubricated at the factory and the wear life and smooth operation of the machine can be assured by lubricating every two months or sooner if required. Lubricate with any good quality synthetic lubricant.



First wipe any excess oil, lint, dirt, etc. from all internal accessible surfaces of the rectangular tubing. Move the bars up and down to allow access to clean the two foot pedal slots and the two hand grip slots. Use paint thinner to remove the oil and lint residue. When clean, wipe or spray a synthetic lubricant on all four internal surfaces of the rectangular tubing.

## PREVENTATIVE MAINTENANCE SCHEDULE

### Daily:

1) Wipe down the main post, base and side rails with a rag and non-solvent, non-ammonia cleaning solution.

### Weekly:

1) Hand check quick-release handle bushings, which the handles lock into, on both sides to make sure they are tight.

2) Check oil level in top reservoir, it should be at least 3/4 full--this should never dip below.  
(Excludes SMA models)

A) If oil level is low, fill using 80/90 gear oil. Oil level should remain at 3/4 full.

B) If you notice the oil has turned dark or black, this is normal. Oil never has to be changed.

## WARNING NOTICE

**In order to maintain highest safety level of equipment, a regular examination is required for damage and wear. This requires a visual inspection of connectors, cables, chains, sprockets, pedals, handles etc. on a regular basis.**

## NOTICE

**Replace defective components immediately and/or keep equipment out of use until repair is made.**

### Monthly:

1) Check bottom chain tightness; with the pedals even you should be able to push the chain in about 1/4 inch. If the chain pushes in more than this, then the chain is loose and will need to be tightened. (See below.)

\*To tighten the chain on the SM VersaClimber, follow the rectangular tube down the back side of the main post until it ends. In the gap at the end of the tube you will find a hex head bolt that's threaded through a hex head nut.

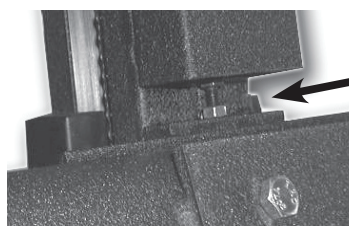

The hex head nut is tightened down against a flat bar, so you'll need a 7/16" open end wrench to loosen it. Loosen the nut away from the flat bar about 2 turns. With

the same 7/16" wrench tighten the hex bolt deeper into the flat bar which will in turn push down the bottom sprocket block and tighten the chain. Tighten the chain until the slack is out, but don't over tighten, you should be able to push the chain in at the side of the machine with your finger about 1/4". When finished tighten the hex nut back down against the flat bar.

Also, if you experience any restricted motion while climbing, the chain may have been over-tightened. If so, go back through this procedure and loosen the screw 1/2 turn, re-tighten nut. Make sure the climbing motion is smooth and un-restricted.

2) Spray internal tracks with Planet Safe AIM lubricants to maintain a smooth running fluid motion. AIM lubricant is available at [www.planetsafelubricants.com](http://www.planetsafelubricants.com) or call our Service Department at 1-800-237-2271

3) Check to make sure the pedals are spinning freely, if not spray pedal shafts with AIM Lubricant.

**NOTE:** Make sure pedal bolts are tight. We recommend replacing pedal shafts every 3 years.



**Quarterly:**

1) Wipe off the top & bottom chains and put a very light coat of Planet Safe AIM grease on chain.



Using a toothbrush, or firm paint brush, brush a light coating of AIM grease on exposed chain.

This is the ONLY place you will use grease on the VersaClimber.

**NOTE:**  
**Never lube the internal tracks with any kind of grease.**

Questions please call 1.800.237.2271 x226

**TROUBLESHOOTING**

If a malfunction occurs, please refer to the following SYMPTOM guide for instruction.

**NOTE:**

TO RECEIVE HELP OR TO EXPEDITE SERVICE PLEASE CALL THE FACTORY. RETURN ALL PARTS TO THE FACTORY WITH A BRIEF NOTE STATING THE NAME, ADDRESS, PHONE NUMBER, CONTACT NAME AND A DESCRIPTION OF THE SYMPTOM. IF A DESCRIPTION OF THE PROBLEM IS NOT INCLUDED WITH THE RETURNED PART, REPAIRS MAY BE SIGNIFICANTLY DELAYED.

CALL 1.800.237.2271

**SYMPTOM:**  
**ALL ZEROS ARE REGISTERING ON MODULE**

If all zeros register on the display when the machine is in motion, there could be a faulty encoder circuit board, broken or loose wire connectors.

With the top, black, plastic cover removed, slowly move the handles up and down. A plastic encoder disc should be seen rotating through a slot that houses sensors. Check to be sure that the disc is clean and the encoder disc tach board and the module are in tact. If no mechanical malfunction is visible, the encoder circuit board may be faulty and should be replaced. If necessary, contact Heart Rate, Inc. for further information.

**SYMPTOM:**

**LCD DIGITS FAIL TO ILLUMINATE**

If the display window is ruptured and the glass top on the LCD is broken, the digits under the broken area will fail to illuminate. The module will need to be removed and returned to Heart Rate, Inc. for LCD replacement and repair. To remove the module, remove the four screws that mount the module to the machine and disconnect the wires from the module. The machine can be used while the module is out for repair.

**SYMPTOM:**

**MACHINE SQUEAK**

A lack of lubrication can cause a squeak in the foot pedal shaft. If rotating the foot pedal while standing on the pedal causes a squeak, lubricate the shaft/pedal interface. If squeak remains, remove the snap ring from the end of the pedal shaft with snap ring pliers being careful not to over extend the ring. Remove the foot pedal and degrease the shaft and pedal hole. If necessary, use fine sandpaper to smooth the shaft surface. Apply grease liberally and reassemble the pedal. Be sure that the snap ring is fully engaged in the snap ring groove.

**SYMPTOM:**

**MACHINE IS "STICKY",  
IRREGULAR OR HARD TO MOVE**

The foot pedals and handgrips are attached to metal bars that move up and down inside C shaped metal channels. The bars have plastic rollers and slides that guide the bars through the channels. Over time the lubricant in the channels picks up dust and lint and dries out producing a "sludge" tar like coating that prevents smooth machine operation. Remove the tar like coating with paint thinner on a rag and the machine will function like brand new (see page 15, roller and slide-bearing).

---

**WARNING NOTICE**

**In order to maintain highest safety level of equipment, a regular examination is required for damage and wear. This requires a visual inspection of connectors, cables, chains, sprockets, pedals, handles etc. on a regular basis.**

**NOTICE**

**Replace defective components immediately and/or keep equipment out of use until repair is made.**

---

**SYMPTOM:  
OIL LEAK FROM HYDRAULIC  
ADJUSTMENT KNOB**

An oil leak from the hydraulic knob (brass knob) indicates either a loose connection or a malfunction in the needle valve. Tighten the nut on the needle valve if it is loose. If leak persists the valve must be replaced. Do not remove the defective valve until you receive the new one. Detailed installation instructions will be included with the replacement valve.

**SYMPTOM:  
OIL LEAK FROM RESERVOIR  
ON TOP OF HYDRAULIC MOTOR**

If oil leaks from the top seal between the black plastic cap and the plastic bowl, tighten cap by hand. If oil leaks from the threads at the base of the accumulator, tighten by turning clockwise with a wrench. If reservoir is physically damaged and a replacement is required, do not remove the reservoir until you receive a new one. The replacement reservoir will include detailed installation instructions. **DO NOT USE THE MACHINE UNLESS THE RESERVOIR IS AT LEAST 3/4 FULL OF OIL.**

---

**WARNING NOTICE**

**In order to maintain highest safety level of equipment, a regular examination is required for damage and wear. This requires a visual inspection of connectors, cables, chains, sprockets, pedals, handles etc. on a regular basis.**

**NOTICE**

**Replace defective components immediately and/or keep equipment out of use until repair is made.**

---

**ADJUSTABLE SEAT (Optional Upgrade)**

In order to use Adjustable Seat, VersaClimber must feature side mount plates (side mount plates are an upgrade feature). The seat assembly easily attaches to the SM VersaClimber by fully inserting a pin through two holes in the mainframe seat bracket of the VersaClimber and through the hole marked with RED arrows on the seat assembly.

Depending on the height of the user, there are 1 to 10 settings to select when adjusting the seat vertically.

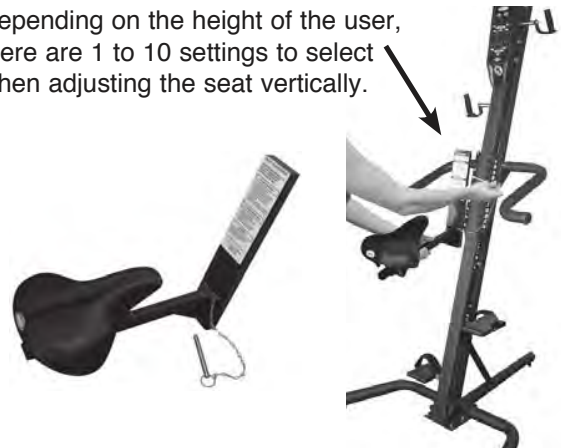

This comfortable seat is adjustable vertically with the pin and horizontally with a knob located under the seat. The vertical seat adjustment is for differences in leg lengths while the horizontal adjustment accounts for differences in arm lengths.

**THE SEAT OPTION PROVIDES THREE  
ADDITIONAL EXERCISES.**

1. Pedal With Legs. Pedal with the legs only in the seated position while holding the stationary hand rails for upper body support.
2. Push And Pull With Arms. Grasp the moving hand grips and push and pull with arms only, allowing the legs to move passively.
3. Exercise Arms And Legs. Pedal with the legs while pushing and pulling with the arms.

The seat transforms the machine into a pedaler, plus a pedaler with upper body exercise. To accommodate differences in limb lengths, it may be necessary to lower the hand grips and adjust the seat horizontally and vertically. Beginners can perform a legs-only exercise comfortably by pushing and pulling with the feet. While bicycles have fixed range of motion, stroke length on the VersaClimber is controlled by the user from 1" to 20" through a complete range of pedaling rates. By grasping the moving hand grips, the muscles of the arms, shoulders, chest and back are added to the leg muscle activity. The seated exercise is for warming up and low to medium level exercises.

## SEAT ADJUSTMENT

The seat assembly easily attaches to the VersaClimber by **fully inserting a pin through two holes in the mainframe of the VersaClimber and one of the holes in the seat assembly.** This comfortable bicycle seat is adjustable vertically with the pin and horizontally with a knob located under the seat. The vertical seat adjustment is for differences in leg lengths while the horizontal adjustment accounts for differences in arm lengths.

**DO NOT ATTEMPT SEAT ADJUSTMENT WHILE STANDING ON FOOT PEDALS OR WHILE SEATED.**

## PEDALING USER GUIDE

The seat provides both a seated legs only exercise and a seated arm and leg exercise. Unlike bicycles, the stroke length is variable from 1" to 20", and the feet can push and pull for a complete leg exercise. By grasping the moving hand grips, the arms, chest and back muscles can be added to the leg muscle activity. The seated exercise is primarily for a warm up and low to medium exercise level.

### NOTE:

**THE SEAT ASSEMBLY WEIGHS 8 POUNDS. IF YOU ARE UNABLE TO SUPPORT THE WEIGHT OF THE SEAT FIRMLY IN ONE HAND, DO NOT ATTEMPT VERTICAL ADJUSTMENT OF THE SEAT WITHOUT ASSISTANCE. DO NOT ATTEMPT SEAT ADJUSTMENT WHILE STANDING ON FOOT PEDALS OR WHILE SEATED.**

## STRENGTH TRAINING

The VersaClimber can be used to develop strength, power and endurance for all of the major muscles of the body. The VersaClimber hydraulic control system provides an ISOKINETIC exercise. ISO: equal; similar. KINETIC: of or provided by motion. The term ISOKINETICS when applied to EXERCISE indicates that THE EXERCISE IS PERFORMED AT THE SAME RATE OF MOTION REGARDLESS OF THE AMOUNT OF FORCE EXERTED. More simply, when the rate of motion is selected, any forces applied by the person pedaling, stepping or climbing, high or low, will be resisted by the hydraulics, at that same pre-selected rate or speed.

## STRENGTH

To develop full body strength, set the hydraulics to a slow rate of motion. Rotate control knob to the right (clockwise) until the desired slow rate of motion is obtained and perform 8 to 12 slow repetitions, Push and pull with both arms and legs in the upward and downward directions.

## POWER

To develop power, set the hydraulics to a faster rate of motion. Rotate control knob to the left (counterclockwise) until the desired speed is obtained and perform 15 to 30 fast repetitions. Push and pull with both arms and legs in the upward and downward directions.

## ENDURANCE

To develop endurance, set the hydraulics at intermediate rates of motion and pedal step or climb for extended periods of time, (30 minutes or more).

## TYPES OF RESISTANCE EXERCISES

With the hydraulic control properly adjusted, the VersaClimber has the capability of providing various strength conditioning exercises. A lat pull, chin up, military/shoulder press, squat, leg press, and leg lift can all be implemented.

## UPPER BODY EXERCISE

The arms, shoulders, chest and back can be isolated by standing on the base plate in front of the VersaClimber and pushing and pulling the moving handles. Position the handles so that they are within reach when the arms are fully extended. Select the desired rate of motion with the hydraulic control knob. With your hands in the start position (palms facing away from you), concentrate on pulling down right then left with your latissimus dorsi (side of back), posterior fibers of deltoids, (back of shoulders) and the triceps brachii (back of arm). This flexion on one side of the body with extension of the other side of the body will tone and trim your sides, stomach, back and back of arms.

To isolate more chest, (pectoralis group), biceps brachii (front of arms), anterior deltoids (front of shoulders) and stomach (abdominals) perform the same pulling action with a reverse grip (palms facing you). Both sets of muscle groups, front and back, can be worked by simultaneously pushing and

pulling right and left. During this upper body only activity, a full range of cyclic rates and stroke lengths can be selected.

## LEG LIFTS, QUAD, AND HAMSTRING SUPER SETS

For isolated leg lifts and leg presses, adjust the velcro foot straps to fit snug on the feet. Set the rate of motion with the hydraulic control knob. Grasp the hand rails to anchor the upper body. Maintain the foot in horizontal position while lifting against the foot straps. Perform the desired activity then recover as you would between intervals. See Interval Training, Page



For the advanced athlete, a “quad burn” can be achieved by squatting down (while holding the stationary hand rails) and performing a stepping exercise. Use the foot straps to secure the feet on the pedals and bend the knees until the thighs are approximately horizontal and the knees straddle the machine. Start with short steps, pushing down with one leg while lifting up with the other.

Maintain the body weight within the base of the machine. Step in the squat position until quads “burn out” or quad fatigue occurs. This exercise can also be performed as an interval workout set.

## FOOT POSITIONING

The position of the foot or feet on the pedals will allow the focus of the work to be in a concentrated area of the muscle or muscles. If tingling or numbness occurs, reposition the foot on the pedal (forward or back) until you are comfortable.

Climbing on heels focuses on quads



Climbing on toes focuses on calves



To concentrate the work on your ankle and calves. Climb on your toes. Quad work can be accentuated by climbing with the heel of the foot forward on the pedal. The intensity of the work for the inner legs can be increased by pointing the toes inward. Turning the toes outward will work the outer legs.

## CROSS BODY, SAME SIDE, AND FULL BODY SETS CLIMBING VS. RUNNING MOTION

All SM VersaClimber models, come with contra-lateral climbing pattern.

KNEE AND ELBOW REMAIN THE SAME DISTANCE APART



CROSS CRAWL PATTERN KNEE AND ELBOW JOIN TOGETHER ON SAME SIDE OF BODY



The contra-lateral or “running motion” provides a unique alternative to the standard “climbing motion.”

A “running motion” is produced as the arm and leg approach each other on one side of body while the opposite arm and leg separate on the other side.

### NOTE:

TO MAINTAIN TRAUMA FREE MOTION, IT IS MANDATORY THAT YOU DO NOT, UNDER ANY CIRCUMSTANCES, “BOTTOM OUT” AT THE END OF EACH STROKE. ALSO, DO NOT HIT THE STEP HEIGHT LIMITERS WHEN THEY ARE IN USE.

## **CROSS BODY AND SAME SIDE STRENGTH SETS**

### **CLIMBING MOTION**

To perform “cross body” strength sets, adjust the hydraulics to the appropriate speed and tighten the foot straps. Climb using cross body forces by pulling down with the arm on one side of the body and lifting with the leg on the other side of the body. Move as though you were going to touch the elbow of the right arm to the opposite knee of the left leg as they come together. Then alternate.

To perform an alternate cross body strength set, push up with the left arm and down with the right leg. Alternate by pushing up with the right arm and down with the left leg.

### **RUNNING MOTION**

To perform “same side” strength sets, adjust the hydraulics to the appropriate speed and tighten the foot straps. Climb using the forces on the same side of the body by pulling down with the arm and lifting up with the leg. Move as though you were going to touch the elbow of right arm to the right knee on the same side of the body. The left arm and knee on the opposite side of the body will separate. Alternate this pulling motion.

To perform an alternate “same side” body strength set, concentrate on pushing up with the right arm and down with the right leg on the same side of the body. Move as though you are trying to push the elbow and the knee away from each other on the same side of the body. The left arm and leg on the opposite side of the body will come together. Alternate this pushing motion.

## **FULL BODY SETS**

**CLIMBING and RUNNING MOTIONS** To perform full body strength sets, adjust the hydraulics to the desired speed and secure the foot straps. Exert upward and downward forces with the arms and simultaneously exert upward and downward forces with the legs. This activity is equivalent to a lat pull and military press for the upper body and a leg press and weighted lift for the lower body.

## **INTERVAL TRAINING**

Interval training on the VersaClimber is for advanced level workouts. User’s should be thoroughly familiar with all functions of the VersaClimber and be able to comfortably climb a minimum of 30 minutes per workout session before attempting this method of conditioning.

Interval training is for the advanced person who wants to increase their aerobic and anaerobic capacity. The purpose of interval training is to increase the intensity of the workload for a short period of time so that the oxygen supplied to the muscles is less than the amount of oxygen required to maintain the workload. An oxygen debt is created in the muscles and therefore they must work anaerobically or without oxygen for a short period of time. The intense portion of the interval is then followed by a short, low intensity, recovery period.

Intervals on the VersaClimber are achieved by sprinting, that is, by increasing the speed and the stroke length of each step (faster rates of motion) or by exerting maximal forces against a preset rate of motion (slower rates of motion). Both of these methods of interval training condition the cardiovascular system to become used to extremely strenuous work loads.

## **AEROBIC INTERVAL TRAINING**

Sprint intervals consist of short sprints (hydraulic control set to a minimum) of 5 - 15 seconds with both arms and legs pushing and pulling in the upward and downward directions (full body sets). Motion should be as quick as possible until the anaerobic threshold (not to exceed 85% of predicted maximal heart rate) is achieved. The foot straps should also be used for vertical lift. The upper torso should remain stable during the sprint interval to

ensure unwasted motion. The interval should be followed by a recovery period of 2 - 3 minutes or until breathing is controlled and muscle fatigue has diminished. Repeat. As you become better conditioned, the rest time between each interval should become shorter.

Remember to always warm up 10 - 15 minutes on the VersaClimber before beginning interval workouts and to always stay within your target heart rate. It is also very important to always continue climbing during recovery periods at a slow, easy pace taking a 2 - 4 inch step. The following aerobic-anaerobic training chart is a general guideline for advanced interval training on the VersaClimber. This advanced training technique is not for beginners or for those who have health problems.

Time/Min	Exercise Description	% of Max HR
0 - 10 min	Warm Up To Aerobic Rate	Resting To 60-75%
10 - 20 min	Aerobic-Anaerobic Interval	
	Training Period:	
	Interval: Exert maximal power (Force and Speed) against a restricted rate of motion set by the hydraulic knob. Push and pull with both arms and legs for 8-12 strokes on each side through a full range of motion. Do not bottom out. Restricted rate of motion should be set to allow user to complete the 8-12 strokes and not exceed the upper percentages of maximal heart rate. After power strokes have been completed, relax and take a shorter, slower step until heart rate returns to lower aerobic recovery level. Start next interval. Complete as many as possible during the interval time limits.	
	Exercise Variations:	
	#1 Forehand Grip, Push and Pull Arms and Legs Aerobic Recovery - Short Slow Steps.	80 - 85% 60 - 65%
	#2 Stationary Hand Rails, Legs Only, Push and Pull Aerobic Recovery - Short Slow Steps.	80 - 85% 60 - 65%
	#3 Reverse Grip, Pull Down Arm, Pull Up Leg, Cross Body Aerobic Recovery - Short Slow Steps.	80 - 85% 60 - 65%
	#4 Forehand Grip Push Up Arm, Push Down Leg, Cross Body Aerobic Recovery - Short Slow Steps.	80 - 85% 60 - 65%
	#5 Forehand Grip, Push and Pull Arms and Legs Aerobic Recovery - Short Slow Steps.	80 - 85% 60 - 65%
	#6 Stationary Hand Rails, Legs Only, Push And Pull Aerobic Recovery - Short Slow Steps.	80 - 85% 60 - 65%
	#7 Reverse Grip, Pull Down Arm, Pull Up Leg, Aerobic Recovery - Short Slow Steps.	80 - 85% 60 - 65%
	#8 Forehand Grip, Push and Pull, Arms and Legs	80 - 85%
	#9 20 - 30 min. Aerobic Speed Work (Hydraulic Control set to minimum)	60 - 65%
	#10 30 - 35 min. Warm Down	70 - 75%

**NOTE: For additional workout programs visit [versaclimber.com](http://versaclimber.com)**

## STRENGTH INTERVAL TRAINING

Strength intervals are achieved in a similar manner to aerobic interval training, except the intervals are performed at a slow rate of motion. First, turn the

1. Warm-up 10-15 minutes on the VersaClimber before beginning interval workouts.
2. Always stay within your target heart rate.
3. Continue climbing during the recovery periods.



First, turn the hydraulic control knob located at the bottom of the console in the clockwise direction, to approximately 75% of the user's capability. Begin climbing, exercising a maximum

effort by pushing and pulling with arm and legs in the upward and downward direction for 5 to 10 seconds or until muscles are almost fatigued and anaerobic threshold is met (not to exceed 85% of your predicted maximal heart rate). Be sure to use the foot straps to maximize the vertical lift. Hands may be in the forward or reverse grip position depending on the desired muscle groups to be worked. Recover from the interval by setting the hydraulic control to a minimum (counter-clockwise direction) and taking short, slow, 2 to 4 inch strokes until breathing is controlled and muscles have recovered. As previously mentioned, as you become better conditioned, the rest period between each interval will become shorter.

**NOTE:** For additional workout programs visit [versaclimber.com](http://versaclimber.com)

## USING THE VERSACLIMBER WITH MINOR INJURIES

### ***MOST MINOR INJURIES THAT PREVENT RUNNING, DO NOT PREVENT CLIMBING***

You must always use common sense when exercising. If you have an injury that hurts when you walk or run, it is common sense to stop walking or stop running. If the injury hurts while climbing, do it easier or do it slower. If it continues to hurt...stop! Consult with your doctor about any injury prior to engaging in an exercise program.

Some leg, knee, arm, chest, shoulder and back injuries can be safely exercised on the VersaClimber by limiting the range of motion or isolating the motion of the injured body part on one or both sides of the body. The smooth, rhythmic, impact free motion will decrease the likeliness of further assault to the injured limb while maintaining or increasing cardiovascular and muscular fitness.

The VersaClimber eliminates all pounding trauma and provides biofeedback information to the user to monitor step heights and step rates. It is ideal for controlled upper and lower body activity for fitness maintenance during the recovery phase of minor injuries.

## LEG INJURIES

The VersaClimber eliminates pounding and jarring of the joints and can therefore be used to exercise such injuries as hamstring pulls, knee injuries, shin splints, achilles pulls, turf toe, leg bruises and sprains. By controlling the rate of climb, the range of motion, and/or by repositioning the foot or feet on the pedal(s), specific areas of the leg and foot may be exercised passively.

## IMMOBILIZATION OF THE LOWER BODY

If the lower body must be completely immobilized due to injury, you can still strengthen your upper body and maintain cardiovascular fitness by doing an arms only workout on the VersaClimber. Stand on the base plate with one foot on each side of the post. Select or reposition the hand grips so that when one arm is outstretched it is fully extended. Alternate the pushing and pulling motion of the arms while the lower body remains still.

## UPPER BODY INJURIES

The arms, chest and shoulders can be totally or partially immobilized while climbing by placing one or both hands on the stationary hand rails. If upper body limb motion is desirable without active muscle contraction, the injured arm can be placed on the moving hand grip and moved passively, without pushing or pulling.

## BACK INJURIES

Exercise that causes back or neck discomfort is frequently the result of either vertical compression loading of the vertebrae or a shearing or bending of the spinal column and back muscles. By keeping the back straight while climbing, with the hydraulic control knob set to a minimum, the discomfort of the injury is minimized. The vertebrae are kept in line rather than being sheared, bent or compressed like with many other conventional exercises. To perform strength workouts, lift with the legs and pull with the arms. These forces tend to elongate the body and stretch the spinal column and provide an otherwise unattainable high level full body workout, without neck or back discomfort. If the lower back injury is such that it cannot be moved at all, you can still exercise the upper body by doing an upper body workout only. If the injury is in the cervical or thoracic areas, (lower or upper spine) one can utilize the VersaClimber by grasping onto the stationary hand rails and simply using the legs only.

## SEATED EXERCISES

The (optional) seat provides an easy sit down routine for beginners and a safe exercise for those who require a non-weight bearing type of activity. Push and pull with any combination of healthy arms and legs to assist the movement of the injured limb or limbs. It is also possible to completely isolate one or both arms or one or both legs while in the non-weight bearing seated position. Set the hydraulic speed control and range of motion limiters to accommodate the injury. The heart rate control mode can also be used to regulate work intensity of the seated arm and leg exercise.

## FOR ZERO RANGE OF MOTION IN KNEE

The VersaClimber can be used for aerobic and strength training by a person in a brace or a thigh to ankle weight bearing cast that can not bend at the knee. Workouts to maximal heart rates and maximal forces can be performed with one totally immobile leg while it may be necessary to walk up to and away from the machine using a crutch or cane (**range of motion limiters are an optional upgrade**).

To exercise, set the range of motion limiter on the same side as the injured leg, so the range of motion in the injured joint is limited. Place the injured leg on the lower foot pedal and keep it straight at all times. Do not bend at the hip, knee or ankle when mounting the VersaClimber. Step on the high foot pedal with the good leg and while holding the hand rails, move until both feet are at the same level. Lower the injured leg to the floor and the good leg will raise to the initial position. Repeat the motion allowing the injured leg to be moved just short of the stop, set to limit the range of motion of the injured leg. The good leg maintains a full range of motion. If the injured leg can be flexed at the knee, set the limiter to allow flexion to the extent that the injury will allow. This will gradually increase flexibility of the limb and work the local muscle groups.

## FOR ZERO RANGE OF MOTION IN ANKLE

For shin splints, achilles tendon pulls, ankle sprains, turf toe and calf pulls, stand on the foot pedal with the heel of the injured foot contacting the pedal. Standing on the heel eliminates both flexion and muscular loading of the ankle, achilles and calf. By pulling with the arm on the injured leg side, further weight bearing loads can be removed from the injured leg. Stand on the foot pedal with the ball of the foot to accentuate ankle and calf muscle usage. Stand on the foot pedal with heel of the foot to accentuate the quad muscle usage.

### NOTE:

**TO MAINTAIN TRAUMA FREE MOTION, IT IS MANDATORY THAT YOU DO NOT, UNDER ANY CIRCUMSTANCES, "BOTTOM OUT" AT THE END OF EACH STROKE. ALSO, DO NOT HIT THE STEP HEIGHT LIMITERS WHEN THEY ARE IN USE.**



# VERSACLIMBER WALL MOUNT OPTION INSTRUCTIONS

## Step 1.

Determine if you will be securing your VC to a concrete wall or a drywall wall with wood studs. It is not recommended to secure a VC to a drywall wall that has steel studs. **(NOTE: Plastic Pump Cover cannot be used when mounting to wall and is not included with unit.)**

## Step 2.

If securing to a cement wall, go to Step 8. If you are securing to drywall with wood studs continue to next step (3).

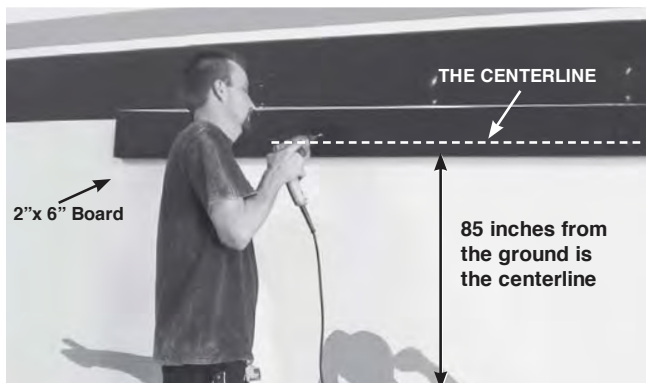

Locate the "center line" of the wood horizontally 85 inches above the floor and secure to at least 2 studs with wood screws or drywall screws at least 3" long.

## Step 3.

A 2" x 6" piece of wood is recommended. The length of the board must span at least two wood studs in the wall when securing your VC. The number of installed VC's determines the length of board. For example, 2 VC's mounted requires a minimum board length of 6' long, properly secured to wall.

## Step 4.

Attach the wall mount bracket to your VC centering the 4 bolts to allow adjustment forward and backward.

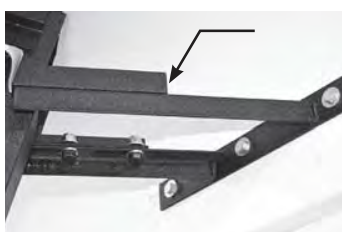
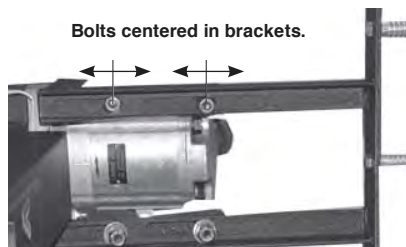

**NOTE:**  
Before mounting to wall, make sure brackets are centered to allow forward and backward adjustment from wall. Brackets stack on top of each other.

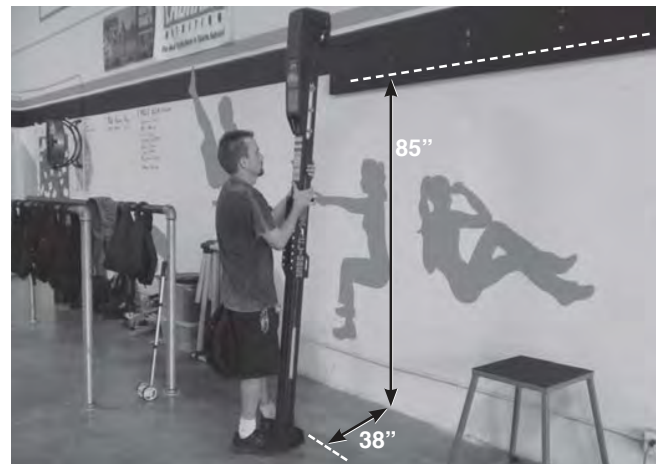

**TOP:**  
85 Inches off floor to establish centerline.

**BOTTOM:**  
38 Inches base plate from wall.

## Step 5.

Stand your VC up and rest the bracket against the piece of wood mounted to the wall. Place the holes of the bracket on the center line you have marked. The front base holes of your VC should be approx. 38 inches in front of wall. Distance can vary depending on wall, baseboards and or where the bracket is positioned.

## Step 6.

Mark the 3 holes on your "center line". Remove your VC and place to the side. Drill the 3 holes through the wood support with a 3/16" drill:

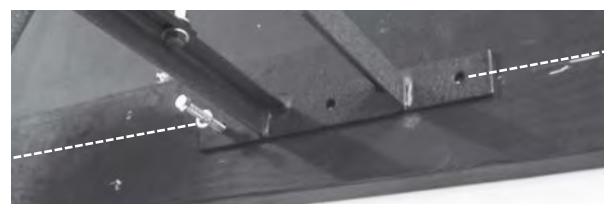

## Step 7.

Place your VC back in place and align the 3 holes. Secure with the three 5/16" lag bolts and washers

supplied then go to Step 13.

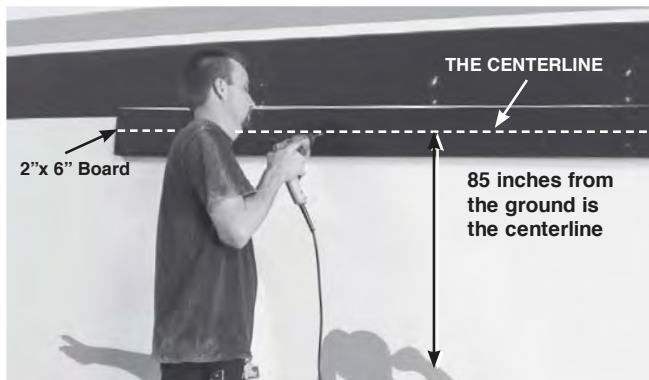

**Step 8.**  
Mounting your VC to cement wall. Mark a line horizontally 85 inches from the floor.

**Step 9.**  
Attached the bracket to you VC using the four bolts, washers and nuts supplied, centering the four bolts to allow adjustment forward and backwards.

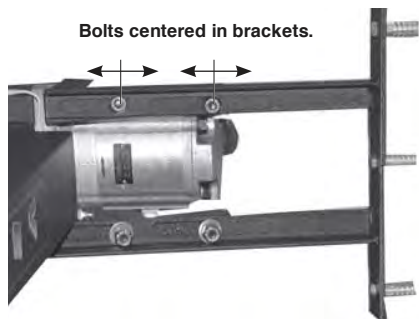

**NOTE:**  
Before mounting to wall, make sure brackets are centered to allow forward and backward adjustment from wall.



**Step 10.**  
Stand your VC up and rest the bracket against the wall. Place the holes of the bracket on the center line you have marked on the wall. The front base holes on the VC should be approximately 38 inches from the wall. This distance may vary depending on the wall, base boards, and or where the bracket is positioned.

**Step 11.**  
Mark the three holes on the centerline. Remove your VC and place to the side. Drill the three holes using 1/2" cement drill bit at least 1 inch deep.



**Step 12.**  
Tap in the three lag shields supplied. Place the VC back in place aligning the three holes secure with three 5/16" lag bolts plus washers supplied.

**NOTE:**  
For multiple units side by side, spacing should be a minimum of 40" from the center of the vertical center line of each unit.

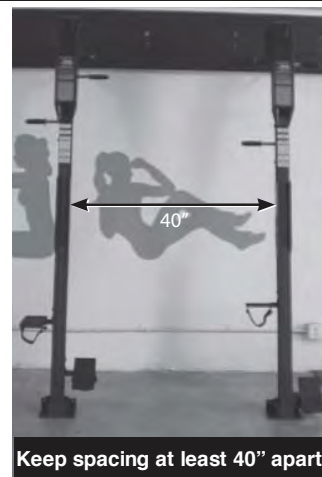

Keep spacing at least 40" apart.

**Step 13.**  
Your VC is now secure to wall. You can adjust your VC closer or farther from the wall to avoid small obstructions. The closer your VC is to the wall the more stable it will be. Adjust your VC if necessary. Determine if the base needs to be secured to the floor for extra stability. Climb on your VC to see if the base moves. If you want to secure to the floor, continue to



lag shields supplied.

**Step 16.**

Replace and secure your VC back to wall making sure bottom holes are aligned. Secure base using the two 5/16" lag and washers supplied. Make sure all bolts and lags are tight.



next step.

**Step 14.**

After you have adjusted the bracket mark the two front base holes on floor.

**Step 15.**

You must remove your VC from the wall to drill the holes on the floor. Set VC off to the side. If you have a wood floor, drill two holes with 3/16" drill at least 1 inch deep. If you have a cement floor, drill 2 holes with 1/2" cement drill at least 1" deep, and tap in two



For further assistance or questions regarding installation, please contact us at 1.800.237.2271

## SPARE PARTS LIST

In the event that a replacement part is ordered from the factory, please refer to the following spare parts list for the correct part description and part number. This information will expedite your shipment when calling our Service Department.

### Electronics

SM Module .....	015-06-000-SM
Tach Assembly, V765 (Bracket, PCB Assy, Cable).....	015-12-000
Encoder Disc .....	013-01-004
Key Pad/LCD/Label Assembly .....	015-05-002-AB

Jack Assembly .....	015-20-000
Tach, Cable Assembly .....	015-15-000
Tach Bracket .....	015-13-000
Top Cover, SM.....	015-25-000
PCB Assembly, SM Module .....	015-05-000-SM
Power Supply US .....	60069

### Moving Parts

Foot Pedal Assembly .....	101-04-000
Foot Pedal Straps.....	008-03-000
Foot Pedal Connector, (Plastic Triangle) .....	008-00-007
Quick Change Handle (1).....	101-06-000
Quick Change Running Handle (1) .....	101-03-000
Handle Grip Only.....	30009
Top Chain.....	043-00-000
Bottom Chain.....	037-00-000
Bar Assy, Top.....	071-00-000
Bar Assy, Bottom.....	148-02-000
Slides.....	003-00-009
Rollers .....	003-00-005
Bottom Sprocket / Tension Assy .....	002-01-000
Bearing .....	30019
Arm Extender Bar Assembly .....	182-02-000
Bushing, Handle .....	101-00-010

### Hydraulic Pump

Pump Assembly, SM.....	039-00-000
Pump Sprocket Bushing .....	30065
Pump Sprocket.....	30010
Accumulator.....	30038
Valve Stem .....	30027
Valve Stem Cover .....	00190
Pump Housing.....	015-21-000

**Structural**

Brackets - Hi-Tri Assembly .....	048-00-000
Brackets - High Five Assembly .....	050-00-000
Base Assembly, (all parts) .....	182-03-000
Brace .....	182-00-008
Bumper Stopper .....	101-00-008
Post Assembly, SM .....	183-01-001
Back Base Support.....	182-03-001
Front Base Support .....	182-03-002
Station Bracket Support (Ears) - Left.....	047-00-005
Station Bracket Support (Ears) - Right.....	047-00-004
PTFE Super Lube lubricant spray .....	30090
Rail Right Side.....	182-00-005
Rail Left Side .....	182-00-006
Rail End Cap .....	30081
Rail Foam .....	60046 32"

**VERSACLIMBER THREE-YEAR  
LIMITED WARRANTY**

1. Heart Rate Inc. (H.R.I.) warrants to the original purchaser that the SM is free from defects in material and workmanship under normal use and proper maintenance with a three year limited warranty subject to the terms and conditions hereafter set forth. Except for the above warranty, it is expressly agreed that **NO WARRANTY OF MERCHANTABILITY OR FITNESS FOR A PARTICULAR PURPOSE** or of a particular use nor any warranty of any kind whatsoever express, implied or statutory is made by H.R.I.
2. This warranty does not cover any damage caused misuse, tampering, negligence, accidents, abnormal conditions, lack of adequate maintenance or unauthorized service or alterations to the product.
3. Liability of H.R.I. is limited to either repair or replacement of the defective part or the replacement of the machine at the option of H.R.I. on an exchange basis, with the customer bearing all costs of shipping and handling to and from the factory.
4. Length of Warranty, Parts.

**ITEM PARTS REPLACEMENT:**

**3 YEAR**

FRAME, HAND RAILS, BASE SUPPORT	3 YEARS
HYDRAULIC MOTOR	3 YEARS

**2 YEAR**

FOOT PEDALS	2 YEARS
HANDLES	2 YEARS
CHAINS AND SPROCKETS	2 YEARS
ROLLERS AND SLIDES	2 YEARS

**1 YEAR**

ELECTRONICS	1 YEAR
HAND GRIP	1 YEAR
FOOT PEDAL STRAPS	1 YEAR
HANDRAIL FOAM COVERS	1 YEAR

5. Length of Warranty, Labor

During the first year, all labor is covered by the warranty. All labor repairs for warranty and non-warranty parts will be performed at the factory. The cost of shipping to and from the factory is the responsibility of the warranty.

6. This warranty does not cover paint deterioration, discoloration, chipping or rust.

7. After all of the foregoing conditions have been complied with, if H.R.I. shall thereupon attempt repairs and /or replacements which shall for any reason fail, H.R.I. shall be allowed to continue to attempt to remedy any defects for so long a period of time as, In H.R.I. sole judgment, such attempt is justified.

8. The foregoing shall be buyer's sole and exclusive remedy, whether based on tort or otherwise, and H.R.I. shall not be liable for any injuries to persons or property. In no event shall H.R.I. be liable for incidental or consequential damages for commercial losses or for any other loss or damages except as above set forth.

9. This warranty is expressly in lieu of all other warranties, express or implied, and of all other obligations or liabilities on the part of H.R.I. No person, firm or corporation is authorized to assume any other liability on behalf of H.R.I.

### CLOSING COMMENTS

This instruction manual, like any instruction manual, is not and cannot be 100% complete. Please contact us if you have any questions or comments after thoroughly reading this manual. We always appreciate receiving inputs from users.

VersaClimber USA  
1411 E. Wilshire Ave.  
Santa Ana, CA 92705

1.800.237.2271

ph: (714) 850.9716 fx: (714) 755.5749

info@versaclimber.com      www.versaclimber.com